



User Guide

DCX700

High-Definition Digital Set-Top Box



© 2010 Motorola, Inc. All rights reserved. No part of this publication may be reproduced in any form or by any means or used to make any derivative work (such as translation, transformation, or adaptation) without written permission from Motorola, Inc.

MOTOROLA and the Stylized M logo are registered in the US Patent and Trademark Office. CableCARD, M-Card , and DOCSIS are trademarks or registered trademarks of Cable Television Laboratories, Inc. HDMI, the HDMI Logo and High Definition Multimedia Interface are trademarks or registered trademarks of HDMI Licensing LLC. Dolby, Pro Logic, and the double-D symbol are registered trademarks of Dolby Laboratories. This product incorporates copyright protection technology that is protected by U.S. patents and other intellectual property rights. Use of this copyright protection technology must be authorized by Rovi, and is intended for home and other limited viewing uses only unless otherwise authorized by Rovi. Reverse engineering or disassembly is prohibited. All other product or service names are the property of their respective owners. All rights reserved. MoCA and the MoCA logo is a trademark of Multimedia over Coax Alliance. The Multimedia over Coax Alliance (MoCA), www.mocalliance.org, is an open, standard body promoting networking of digital video and entertainment through existing coaxial cable in the home.

Motorola reserves the right to revise this publication and to make changes in content from time to time without obligation on the part of Motorola to provide notification of such revision or change. Motorola provides this guide without warranty of any kind, implied or expressed, including, but not limited to, the implied warranties of merchantability and fitness for a particular purpose. Motorola may make improvements or changes in the product(s) described in this manual at any time.



Safety & Regulatory Information

IMPORTANT SAFETY INSTRUCTIONS

- Read these instructions.
- Keep these instructions.
- Heed all warnings.
- Follow all instructions.
- Do not use this apparatus near water.
- Clean only with dry cloth.
- Do not block any ventilation openings. Install in accordance with the manufacturer's instructions.
- Do not install near any heat sources such as radiators, heat registers, stoves, or other apparatus (including amplifiers) that produce heat.
- Do not defeat the safety purpose of the polarized or grounding-type plug. A polarized plug has two blades with one wider than the other. A grounding type plug has two blades and a third grounding prong. The wide blade or the third prong is provided for your safety. If the provided plug does not fit into your outlet, consult an electrician for replacement of the obsolete outlet.
- Protect the power cord from being walked on or pinched particularly at plugs, convenience receptacles, and the point where they exit from the apparatus.
- Only use attachments/accessories specified by the manufacturer.
- Unplug this apparatus during lightning storms or when unused for long periods of time.
- Refer all servicing to qualified service personnel. Servicing is required when the apparatus has been damaged in any way, such as the power supply cord or plug is damaged, liquid has been spilled or objects have fallen into the apparatus, the apparatus has been exposed to rain or moisture, does not operate normally, or has been dropped.

Important Safety Considerations

- The mains plug is the main disconnect device. It shall remain readily accessible and operable.
- The apparatus shall not be exposed to dripping or splashing and no objects filled with liquids, such as vases, shall be placed on the apparatus.
- WARNING: To reduce the risk of fire or electric shock, do not expose this apparatus to rain or moisture.
- WARNING: Batteries shall not be exposed to excessive heat such as sunshine, fire or the like.
- See label on bottom of unit for additional markings.

During Transportation to the Subscriber Home

- Transport the cable terminal in its shipping box or an equally padded container.
- Do not expose the terminal to rain or moisture.

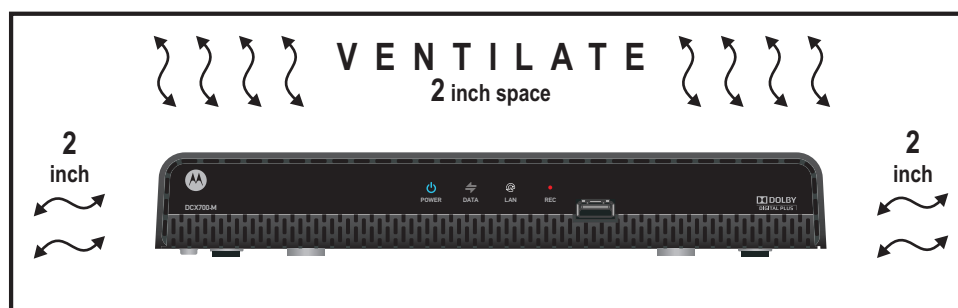

During Installation

- Do not place the terminal in an enclosed area where the cooling vents are blocked or impede the flow of air through the ventilation openings.
- Install the terminal so that its position does not interfere with its proper ventilation. For example, do not place the terminal on a bed, sofa, rug, or similar surface that could block the ventilation openings.
- Install the terminal so that there is a minimum of two inches of space between surrounding surfaces and the top, left, and right sides of the terminal to ensure proper ventilation.
- Install the terminal away from heat sources such as radiators, heat registers and stoves. Installation of the terminal near consumer electronics devices, such as stereo receiver/amplifiers and televisions, is permitted as long as the air surrounding the terminal does not exceed 40° C (104° F).
- Place the terminal on a flat surface not prone to vibration or impact.
- Do not place the terminal on top of another electronic device.
- Do not install the terminal in an area where condensation occurs.
- To prevent the temporary loss of guide data and cause a temporarily non-responding terminal, do not plug the AC power cord into a switched power outlet.
- For DCX700 North American models, only use power supplies with Motorola part number 524475-034.

FCC Compliance

Note: This equipment has been tested and found to comply with the limits for a Class B digital device, pursuant to part 15 of the FCC Rules. These limits are designed to provide reasonable protection against harmful interference in a residential installation. This equipment generates uses and can radiate radio frequency energy and, if not installed and used in accordance with the instructions, may cause harmful interference to radio communications. However, there is no guarantee that interference will not occur in a particular installation. If this equipment does cause harmful interference to radio or television reception, which can be determined by turning the equipment off and on, the user is encouraged to try to correct the interference by one or more of the following measures:

- Reorient or relocate the receiving antenna.
- Increase the separation between the equipment and receiver.
- Connect the equipment into an outlet on a circuit different from that to which the receiver is connected.
- Consult the dealer or an experienced radio/TV technician for help.



CAUTION *Changes or modifications not expressly approved by Motorola for compliance could void the user's authority to operate the equipment.*

This device complies with part 15 of the FCC Rules. Operation is subject to the following two conditions: (1) This device may not cause harmful interference, and (2) this device must accept any interference received, including interference that may cause undesired operation.

FCC Declaration of Conformity

Motorola Inc., Home & Network Mobility, 101 Tournament Drive, Horsham, PA 19044, 1-215-323-1000, declares that the DCX700 set-top complies with 47 CFR Parts 2 and 15 of the FCC rules as a Class B digital device.

Industry Canada (IC)

This Class B digital device complies with Canadian ICES-003.

Cet appareil numérique de la classe B est conforme à la norme NMB-003 du Canada.

Caring for the Environment by Recycling



When you see this symbol on a Motorola product, do not dispose of the product with residential or commercial waste.

Recycling your Motorola Equipment

Please do not dispose of this product with your residential or commercial waste. Some countries or regions, such as the European Union, have set up systems to collect and recycle electrical and electronic waste items. Contact your local authorities for information about practices established for your region. If collection systems are not available, call Motorola Customer Service for assistance.



Software License

Software License

IMPORTANT: PLEASE READ THIS SOFTWARE LICENSE ("LICENSE") CAREFULLY BEFORE YOU USE ANY SOFTWARE, FIRMWARE AND RELATED DOCUMENTATION ("SOFTWARE") PROVIDED WITH MOTOROLA'S DIGITAL CABLE RECEIVER OR HOME THEATER SYSTEM (EACH SHALL BE REFERRED TO IN THIS LICENSE AS A "RECEIVER"). BY USING THE RECEIVER AND/OR USING ANY OF THE SOFTWARE, YOU INDICATE YOUR ACCEPTANCE OF EACH OF THE TERMS OF THIS LICENSE. UPON ACCEPTANCE, THIS LICENSE WILL BE A LEGALLY BINDING AGREEMENT BETWEEN YOU AND MOTOROLA. THE TERMS OF THIS LICENSE APPLY TO YOU AND TO ANY SUBSEQUENT USER OF THIS SOFTWARE.

IF YOU DO NOT AGREE TO ALL OF THE TERMS OF THIS LICENSE (I) DO NOT USE THE SOFTWARE AND (II) RETURN THE RECEIVER AND THE SOFTWARE (COLLECTIVELY, "PRODUCT"), INCLUDING ALL COMPONENTS, DOCUMENTATION AND ANY OTHER MATERIALS PROVIDED WITH THE PRODUCT, TO YOUR POINT OF PURCHASE OR SERVICE PROVIDER, AS THE CASE MAY BE, FOR A FULL REFUND.

The Software includes associated media, any printed materials, and any "on-line" or electronic documentation. Software provided by third parties may be subject to separate end-user license agreements from the manufacturers of such Software. The Software is never sold. Motorola licenses the Software to the original customer and to any subsequent licensee for personal use only on the terms of this License. Motorola and its third party licensors retain the ownership of the Software.

You may:

USE the Software only in connection with the operation of the Product.

TRANSFER the Software (including all component parts and printed materials) permanently to another person, but only if the person agrees to accept all of the terms of this License. If you transfer the Software, you must at the same time transfer the Product and all copies of the Software (if applicable) to the same person or destroy any copies not transferred.

TERMINATE this License by destroying the original and all copies of the Software (if applicable) in whatever form.

You may not:

(1) Loan, distribute, rent, lease, give, sublicense or otherwise transfer the Software, in whole or in part, to any other person, except as permitted under the TRANSFER paragraph above. (2) Copy or translate the User Guide included with the Software, other than for personal use. (3) Copy, alter, translate, decompile, disassemble or reverse engineer the Software, including but not limited to, modifying the Software to make it operate on non-compatible hardware. (4) Remove, alter or cause not to be displayed, any copyright notices or startup message contained in the Software programs or documentation. (5) Export the Software or the Product components in violation of any United States export laws.

The Product is not designed or intended for use in on-line control of aircraft, air traffic, aircraft navigation or aircraft communications; or in design, construction, operation or maintenance of any nuclear facility. MOTOROLA AND ITS THIRD PARTY LICENSORS DISCLAIM ANY EXPRESS OR IMPLIED WARRANTY OF FITNESS FOR SUCH USES. YOU REPRESENT AND WARRANT THAT YOU SHALL NOT USE THE PRODUCT FOR SUCH PURPOSES.

Title to this Software, including the ownership of all copyrights, mask work rights, patents, trademarks and all other intellectual property rights subsisting in the foregoing, and all adaptations to and modifications of the foregoing shall at all times remain with Motorola and its third party licensors. Motorola retains all rights not expressly licensed under



this License. The Software, including any images, graphics, photographs, animation, video, audio, music and text incorporated therein is owned by Motorola or its third party licensors and is protected by United States copyright laws and international treaty provisions. Except as otherwise expressly provided in this License, the copying, reproduction, distribution or preparation of derivative works of the Software, any portion of the Product or the documentation is strictly prohibited by such laws and treaty provisions. Nothing in this License constitutes a waiver of Motorola's rights under United States copyright law.

This License and your rights regarding any matter it addresses are governed by the laws of the Commonwealth of Pennsylvania, without reference to conflict of laws principles. THIS LICENSE SHALL TERMINATE AUTOMATICALLY if you fail to comply with the terms of this License.

Motorola is not responsible for any third party software that is provided as a bundled application, or otherwise, with the Software or that is downloaded to, or otherwise installed on, the Product.

U.S. GOVERNMENT RESTRICTED RIGHTS

The Product and documentation is provided with RESTRICTED RIGHTS. The use, duplication or disclosure by the Government is subject to restrictions as set forth in subdivision (c)(1)(ii) of The Rights in Technical Data and Computer Software clause at 52.227-7013. The contractor/manufacturer is Motorola, Inc., Home & Network Mobility, 101 Tournament Drive, Horsham, PA 19044.



Contents

| | |
|---|-----------|
| Safety & Regulatory Information | i |
| Software License | iv |
| Introduction | 1 |
| Front Panel..... | 2 |
| Rear Panel..... | 3 |
| Operation | 4 |
| Turning Power On and Off | 4 |
| Changing Channels | 4 |
| Adjusting the Volume | 4 |
| Interactive Program Guide..... | 4 |
| M-Card™..... | 4 |
| Connecting Your Set-Top | 5 |
| Video Connection Options..... | 5 |
| HDMI or IEEE-1394 — HDTV and SDTV..... | 5 |
| Component video (YPbPr) — HDTV and SDTV..... | 6 |
| Composite Video (also referred to as Video) — SDTV..... | 6 |
| Connecting HDTV — Single Connection for Video/Audio..... | 6 |
| Cable In | 6 |
| HDMI..... | 6 |
| IEEE-1394 (M/Card/US models only) | 6 |
| Connecting Your DCX Set-top to an HDTV — Video..... | 7 |
| Connecting HDTV — Separate Video/Audio Connections..... | 8 |
| Cable In | 8 |
| DVI..... | 8 |
| Component Video (YPbPr) | 8 |
| Audio | 8 |
| Connecting Your DCX Set-top to an HDTV — Audio..... | 9 |
| Connecting an HDTV and an A/V Receiver..... | 10 |
| Connecting Your DCX Set-top to an A/V Receiver — Video..... | 11 |
| Connecting Your DCX Set-top to an A/V Receiver — Audio | 12 |
| Connecting an SDTV..... | 13 |
| Connecting Your DCX Set-top to an SDTV | 13 |
| Connecting an SDTV and VCR/DVD Recorder..... | 14 |
| Connecting Your DCX Set-top to an SDTV and VCR/DVD Recorder | 14 |
| Connecting an A/V Receiver, SDTV, and VCR/DVD Recorder..... | 15 |



| | |
|--|-----------|
| Connecting Your DCX Set-top to an A/V Receiver, SDTV, and VCR/DVD Recorder | 16 |
| Recording Your Connections..... | 17 |
| Data Devices..... | 18 |
| Data Features | 18 |
| On-Screen Graphics | 19 |
| Configuring A/V and Closed Caption Settings..... | 20 |
| Native Mode Settings Screen | 25 |
| Additional HDMI Settings Screen | 28 |
| Additional Closed Caption Settings Screen..... | 30 |
| Subtitle and DVS Settings Screen..... | 32 |
| Advanced Audio/Video Settings Screen..... | 34 |
| Troubleshooting | 36 |
| Appendix A..... | 39 |
| Wall Mounting Your DCX700..... | 39 |



1

Introduction

Congratulations on receiving a Motorola DCX700 High-Definition All-Digital Cable Set-top box, one of the most advanced interactive digital cable set-tops available today. Motorola has merged the extraordinary features of digital cable — the seemingly endless programming options, interactive program guides, Video on Demand (VOD), commercial-free, CD quality music, and the incredible picture quality and sound of High-Definition TV (HDTV).

This set-top includes an “Entertainment Package” that enables a direct digital connection to consumer audio and video devices through IEEE-1394 and HDMI™ interfaces. Dolby® Digital Plus is supported by the HDMI interface and provides 7.1 channels and beyond of enhanced-quality audio.

This User Guide introduces you to the basic features, outlines important safeguards, and provides several options for integrating this component into your current entertainment system. Please take a few moments to read through this User Guide; the configuration diagrams, on-screen menu description and troubleshooting section will help you make the most of your home entertainment experience.

To determine which features of digital cable are provided in your service area, please check with your local cable operator. They will be happy to provide instructions for these optional services.

Features:

- Integrated MoCA™ networking (only available on DCX700-M model)
- HDMI, Component, IEEE-1394 (M-Card/US models only), Composite, Digital Audio (S/PDIF), Audio L/R, Ethernet, USB
- 1080p 24/30 video decode & output support



Front Panel

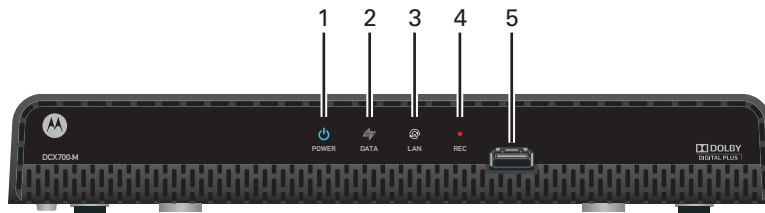

| | |
|---|--|
| 1 | Power LED — Illuminates when the DCX700 is powered on |
| 2 | Data — Dual function LED <ul style="list-style-type: none"> • Flashes to indicate unit is booting/provisioning • Extinguished when unit is provisioned |
| 3 | LAN — Illuminates to indicate one or more set-top boxes and/or DVR devices are detected on the home network |
| 4 | Rec — Unit is in record mode on a home network device (only available on DCX700-M model with MoCA option) |
| 5 | USB connector* |

**The availability of certain features is dependent upon application support.*



Rear Panel

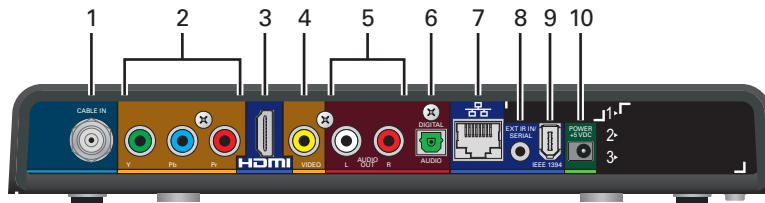

| | |
|----|--|
| 1 | Cable In — Connects to cable signal from the service provider |
| 2 | Video outputs / YPbPr — Component video output (HDTV) |
| 3 | HDMI™ — High-Definition TV (HDTV) connector (Provides Dolby® Digital Plus (7.1) audio) |
| 4 | Video Out — Composite Video (SDTV) |
| 5 | Baseband Audio Out — L/R audio |
| 6 | Digital Audio (optical) — Provides Dolby® Digital 5.1 audio or PCM output |
| 7 | Ethernet* — Network connection |
| 8 | Ext IR Input – Connects to a remote control receiver accessory cable |
| 9 | IEEE-1394 — Audio and video device connection |
| 10 | Power connector |

* Availability of certain features is dependent upon application support.



2

Operation

Turning Power On and Off

Press **POWER** on the remote control to turn the DCX set-top on or off (standby). Be sure the remote control is in cable mode by pressing **CABLE** before pressing **POWER**.

Changing Channels

You can change channels in three ways:

- Press **CHANNEL +** or **-** on the remote control to step through the channel selection.
- Enter the number of the channel you wish to view using the number keys on the remote control.
- Select the channel in the Interactive Program Guide.

Adjusting the Volume

Press **VOLUME +** or **-** on the remote control to adjust the volume. When you adjust the volume, the volume scale is displayed on the screen. Press **MUTE** on the remote control to toggle the sound on and off.

For best audio quality when using the analog L/R audio outputs, use the remote control to set the DCX set-top to approximately three quarters of the maximum volume level and then adjust the audio levels on external devices such as your TV or A/V receiver.

Interactive Program Guide

The Interactive Program Guide displays information about TV programs and enables you to access features such as Parental Control or Pay-Per-View. Interactive program guides can vary with each cable service provider. Refer to the Interactive Program Guide's instruction manual for detailed instructions.

M-Card™

The M-Card is required to view cable television programs and interactive on-demand programs. The M-Card should not be removed.



3

Connecting Your Set-Top

Instructions and diagrams are included for the following connections:

- High-Definition TV (HDTV)
- A/V receiver — Audio
- Standard-Definition TV (SDTV)
- Standard-Definition TV (SDTV) and VCR/DVD Recorder
- A/V receiver, Standard-Definition TV (SDTV), and VCR/DVD Recorder

Before you move or change components on your entertainment system, review the following:

- For basic cable connections, use 75-ohm coaxial cables equipped with F-type connectors
- Disconnect power from your equipment before connecting or changing cable connections

CAUTION Do not place anything on top of your DCX set-top, especially other home entertainment components. Be sure to provide adequate ventilation to prevent overheating.

Video Connection Options

The DCX set-top offers several different video connection options. Component video, HDMI, and IEEE-1394 allow you to view both High-Definition and Standard-Definition TV programming. Composite video connection allows you to view only Standard-Definition TV programming.

To determine whether your TV features component video, HDMI, IEEE-1394, or composite video, check the manual supplied with your TV.

Use the guidelines below to determine the best video connection for your home entertainment system.

Note: Only (1) video connection to the TV is required. HD video can only be viewed with HDMI, IEEE-1394, or component video connections.

HDMI or IEEE-1394 — HDTV and SDTV

HDMI and IEEE-1394 offer higher quality HD video than component video.

If your TV has an HDMI input, this is for both audio and video. Connect a Standard HDMI cable to the TV and to the HDMI connector on your DCX set-top.



HDMI and IEEE-1394 outputs provide video and audio, so no separate audio connections are required if you plan to use your TV's speakers as the primary audio source.

On-screen graphics will not be displayed when you are using the IEEE-1394 connection on the rear panel of the DCX set-top. Refer to *Section 5* for more information.

If your TV has a DVI input, connect a DVI-to-HDMI adapter or cable to the HDMI out connector on the DCX set-top and the DVI-HDTV connector on your TV.

Note: DVI does not provide audio. A separate audio connection must be made. IEEE-1394 connection is available only on M-card/US models.

Component video (YPbPr) — HDTV and SDTV

The YPbPr connectors on your DCX set-top provide HDTV and SDTV component video.

Note: Component video does not provide audio. A separate audio connection must be made.

Composite Video (also referred to as Video) — SDTV

If none of the above inputs are available on your TV, use the composite video (video) connection.

Note: Composite video does not provide audio. A separate audio connection must be made.

Connecting HDTV — Single Connection for Video/Audio

Cable In

Connect an RF coaxial cable to the cable wall outlet and the cable in connector on the DCX set-top.

HDMI

If your TV has an HDMI input, this is for both audio and video if you are using the TV speakers. Connect a Standard HDMI cable to the TV and to the HDMI connector on your DCX set-top.

IEEE-1394 (M/Card/US models only)

If your HDTV has an IEEE-1394 connector, you can use the IEEE-1394 for both your video and audio connection. Connect an IEEE-1394 cable to the IEEE-1394 connector on your HDTV and DCX set-top.

Note: On-screen graphics will not be displayed when you are using the IEEE-1394 connection on the rear panel of the DCX set-top. Refer to Section 5 for more information.

If you have an audio/video receiver and are not using your TV's speakers, go to *Connecting Your DCX Set-top to an A/V Receiver — Audio*.



Connecting Your DCX Set-top to an HDTV — Video

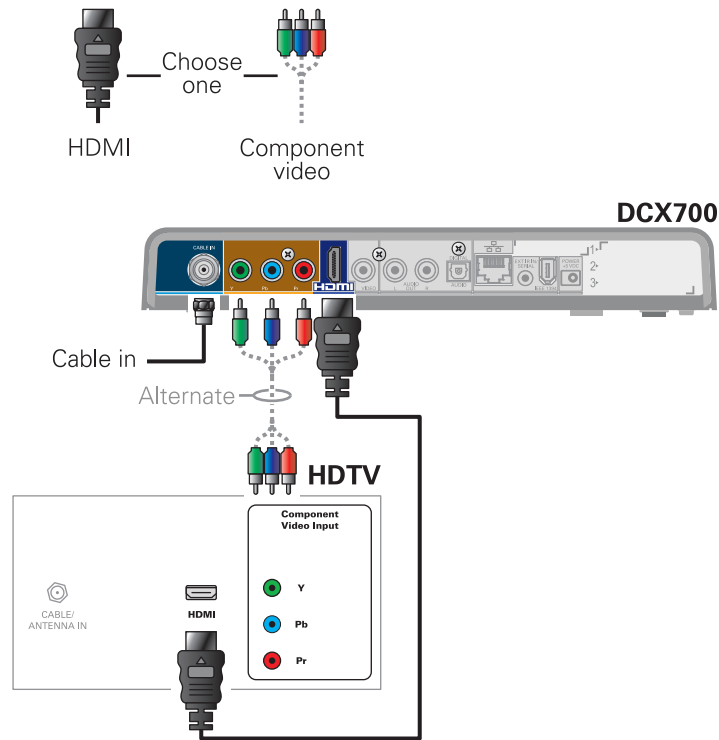

Note: Because HDMI provides both video and audio output, no additional audio connections to the TV are required.

Note: Only (1) HDTV video connection needs to be made to an HDTV.

Note: Solid lines indicate optimum connections.



Connecting HDTV — Separate Video/Audio Connections

Cable In

Connect an RF coaxial cable to the cable wall outlet and the **CABLE IN** connector on the DCX set-top and then choose one of the following:

DVI

If your TV has a DVI input, use the DVI connection for your video, connect a HDMI-to-DVI adapter or cable to the HDMI out connector on the DCX set-top and the **DVI-HDTV** connector on your TV.

Note: A DVI connection supports only the video connection between the DCX set-top and the HDTV.

To connect your audio connections with your TV speakers, go to Audio on the next page.

To connect your audio connections for an A/V receiver, go to Connecting an A/V Receiver — Audio.

Component Video (YPbPr)

Connect the component video cables to the Y, Pb, and Pr connectors on your HDTV and DCX set-top.

Note: This connection only supports the video connection between the DCX set-top and the HDTV.

Note: Be sure to match up each signal to the same connection on the TV, otherwise the colors will not appear correctly on your TV.

To connect your audio connections with your TV speakers, go to Audio on the next page.

To connect your audio connections for an A/V receiver, go to Connecting an A/V Receiver — Audio.

Audio

If your TV does not have digital audio inputs, connect the stereo audio cable to the **AUDIO L/R** connectors on the DCX700 set-top and the **AUDIO L/R** connectors on the HDTV.

If your TV supports digital audio inputs, use the digital audio **OPTICAL S/PDIF** output instead of the **AUDIO L/R** outputs. S/PDIF offers better audio quality, including support for Dolby® Digital audio.

For information on configuring your DCX set-top settings, go to Configuring the Audio, Video, and Closed Caption Settings.



Connecting Your DCX Set-top to an HDTV — Audio

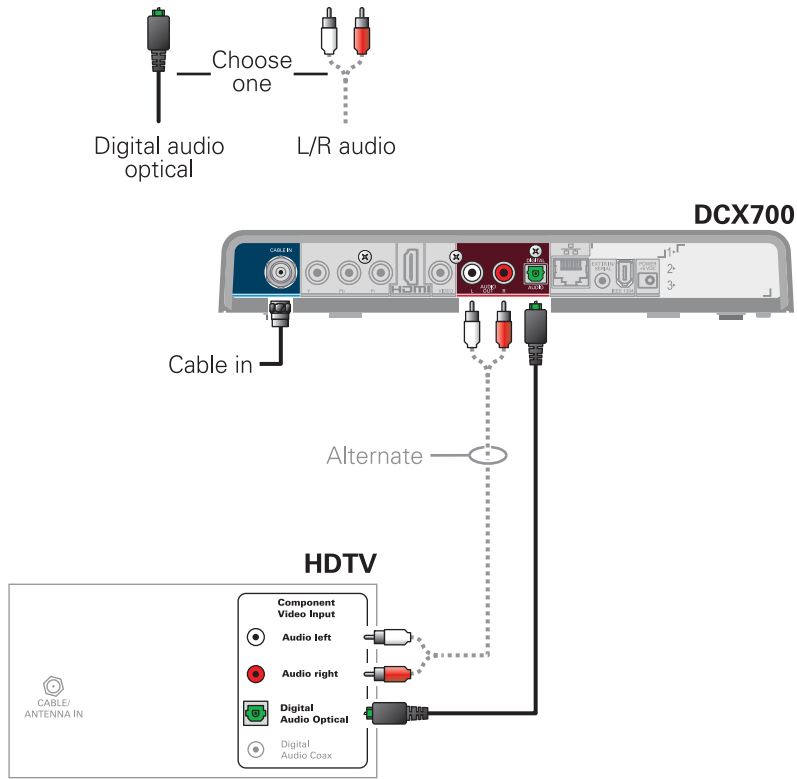

Note: Only (1) video connection and (1) audio connection needs to be made to an HDTV.

Note: Solid lines indicate optimum connections.



Connecting an HDTV and an A/V Receiver

There are several options available for audio connections to your A/V receiver:

- HDMI
- Digital audio (OPTICAL S/PDIF)
- Stereo audio (AUDIO L/R)

If your A/V receiver supports it, the optical (S/PDIF) digital audio output may be used in place of the stereo audio outputs (AUDIO L/R). These outputs offer a higher level of audio quality, including support for Dolby Digital audio.

- **Digital audio optical (S/PDIF)** — Connect the optical cable to the digital audio optical connector on the DCX set-top and the optical connector on the A/V receiver.
- **Stereo audio** — Connect the stereo audio cable to the AUDIO L/R connectors on the DCX set-top and the AUDIO L/R connectors on the A/V receiver.

For information on configuring your DCX set-top settings, see [Configuring the Audio, Video, and Closed Caption Settings](#).



Connecting Your DCX Set-top to an A/V Receiver — Video

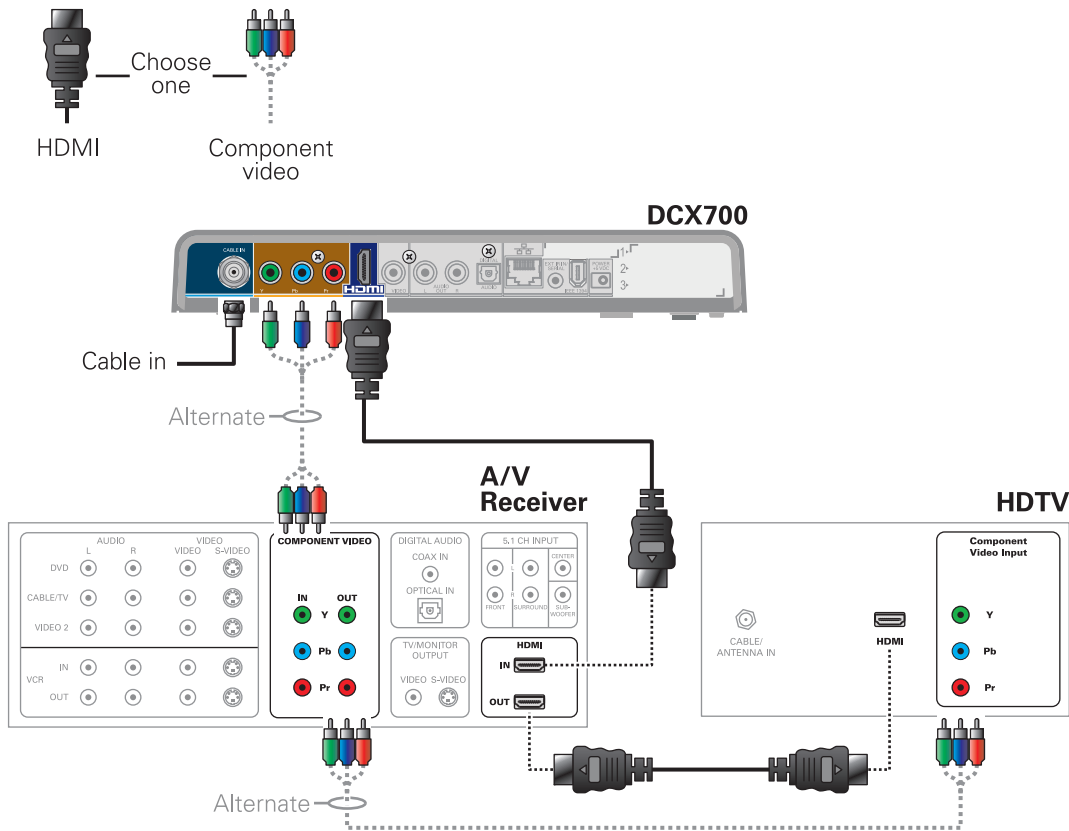

Note: Solid lines indicate optimum connections.

Note: Because HDMI provides both video and audio output, no additional audio connections to the TV or A/V Receiver are required.



Connecting Your DCX Set-top to an A/V Receiver — Audio

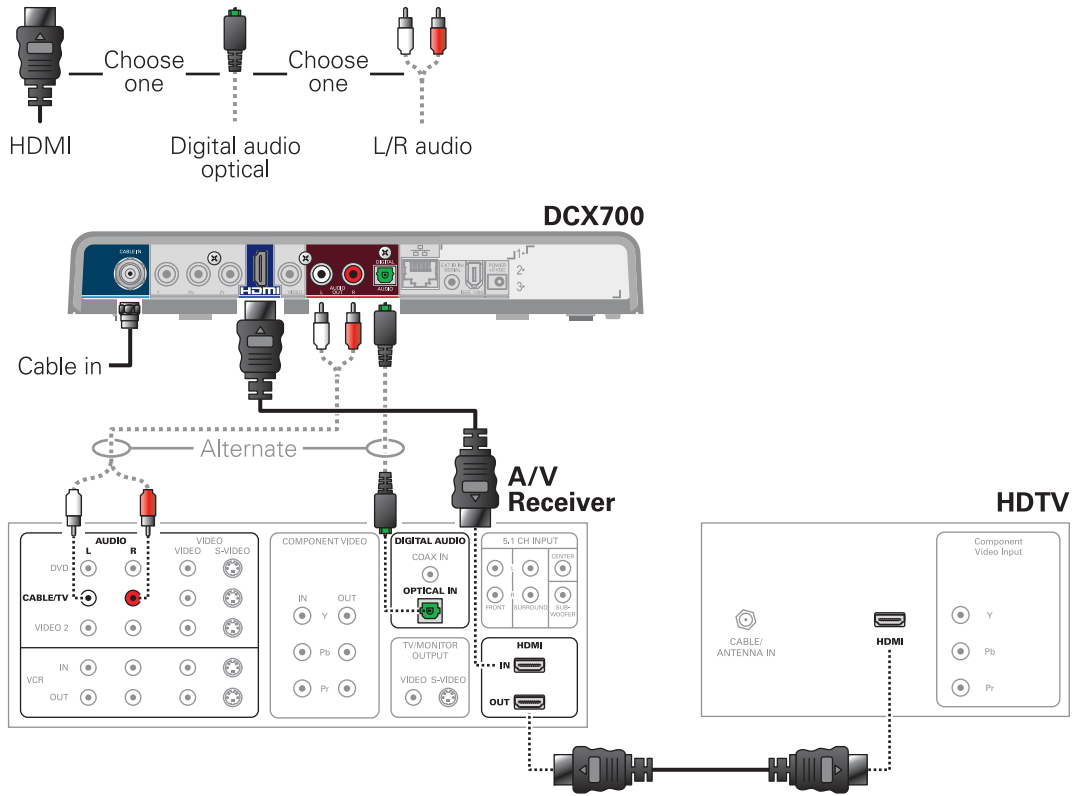

Note: Solid lines indicate optimum connections.



Connecting an SDTV

1. Connect the stereo audio cable to the AUDIO L/R connectors on the DCX set-top and the AUDIO L/R connectors on the Standard-Definition TV (SDTV).
2. Connect a composite video cable to the VIDEO OUT connector on the DCX set-top and the INPUT composite video on the TV.

These video connection methods do not support HD video. If you have an HDTV, see [Connecting HDTV — Single Connection for Video/Audio](#).

Connecting Your DCX Set-top to an SDTV

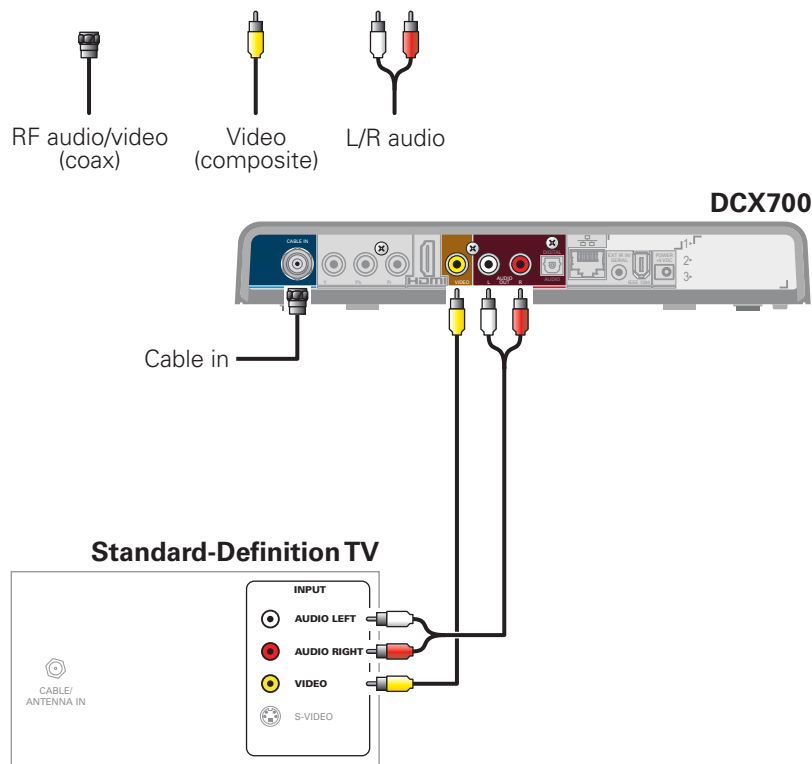

Note: Only (1) video connection and (1) audio connection is required.



Connecting an SDTV and VCR/DVD Recorder

1. Connect a stereo audio cable to the **AUDIO L/R** connectors on the DCX700 set-top and the **INPUT AUDIO L/R** connectors on the VCR/DVD recorder.
2. Connect a composite video cable to the **VIDEO OUT** connector on the DCX700 set-top and the **INPUT VIDEO** connector on the VCR/DVD recorder.
3. Connect a stereo audio cable to the **OUTPUT AUDIO L/R** connectors on the VCR/DVD recorder and the **INPUT AUDIO LEFT** and **RIGHT** connectors on the Standard-Definition TV (SDTV).
4. Connect a composite video cable to the output video connector on the VCR/DVD recorder and the input video connector on the Standard-Definition TV (SDTV).

Note: You can also connect using the S-Video connectors if supported by your VCR/DVD recorder and SDTV.

These video connection methods do not support HD video. If you have an HDTV, see *Connecting HDTV — Single Connection for Video/Audio*.

Connecting Your DCX Set-top to an SDTV and VCR/DVD Recorder

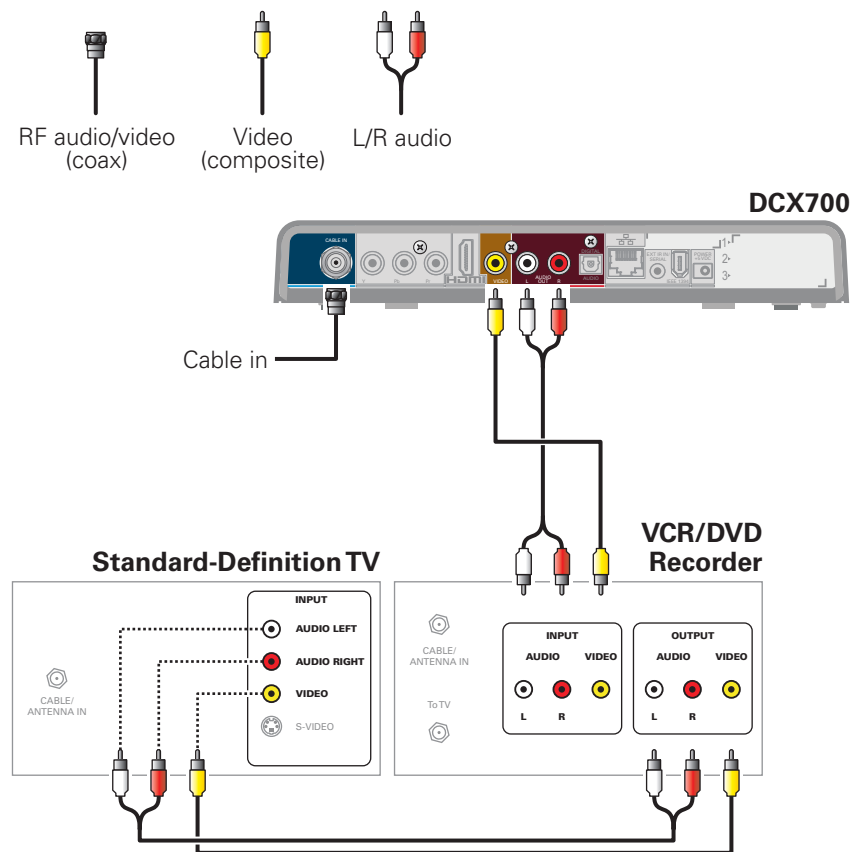



Connecting an A/V Receiver, SDTV, and VCR/DVD Recorder

1. Connect a stereo audio cable to the AUDIO OUT L/R connectors on the DCX set-top and the INPUT L/R connectors on the A/V receiver.
2. Connect a composite video cable to the VIDEO OUT connector on the DCX set-top and the VIDEO connector on the A/V receiver.
3. Connect a stereo audio cable to the VCR/DVD RECORDER AUDIO OUT L/R connectors on the A/V receiver and the INPUT AUDIO L/R connectors on the VCR/DVD recorder.
4. Connect a stereo audio cable to the AUDIO OUT L/R connectors on the VCR/DVD recorder and the VCR AUDIO IN L/R connectors on the A/V receiver.
5. Connect a composite video cable to the INPUT VIDEO connector on the VCR/DVD recorder and the composite VIDEO VCR OUT CONNECTOR on the A/V receiver.
6. Connect a composite video cable to the COMPOSITE VIDEO OUT connector on the VCR/DVD recorder and the VIDEO VCR IN connector on the A/V receiver.
7. Connect a S-Video cable to the S-VIDEO connector IN on the Standard-Definition TV (SDTV) and the TV/MONITOR S-Video OUT connector on the A/V receiver.

Note: If your TV or A/V receiver does not support S-Video connections. Composite video connections may be used in place of S-Video connection.

Note: The digital optical audio (optical S/PDIF) output may be used in place of the stereo audio outputs (audio L/R). These outputs offer a higher level of audio quality, including support for Dolby Digital audio.

These video connection methods do not support HD video. If you have an HDTV, see Connecting HDTV — Single Connection for Video/Audio.



Connecting Your DCX Set-top to an A/V Receiver, SDTV, and VCR/DVD Recorder

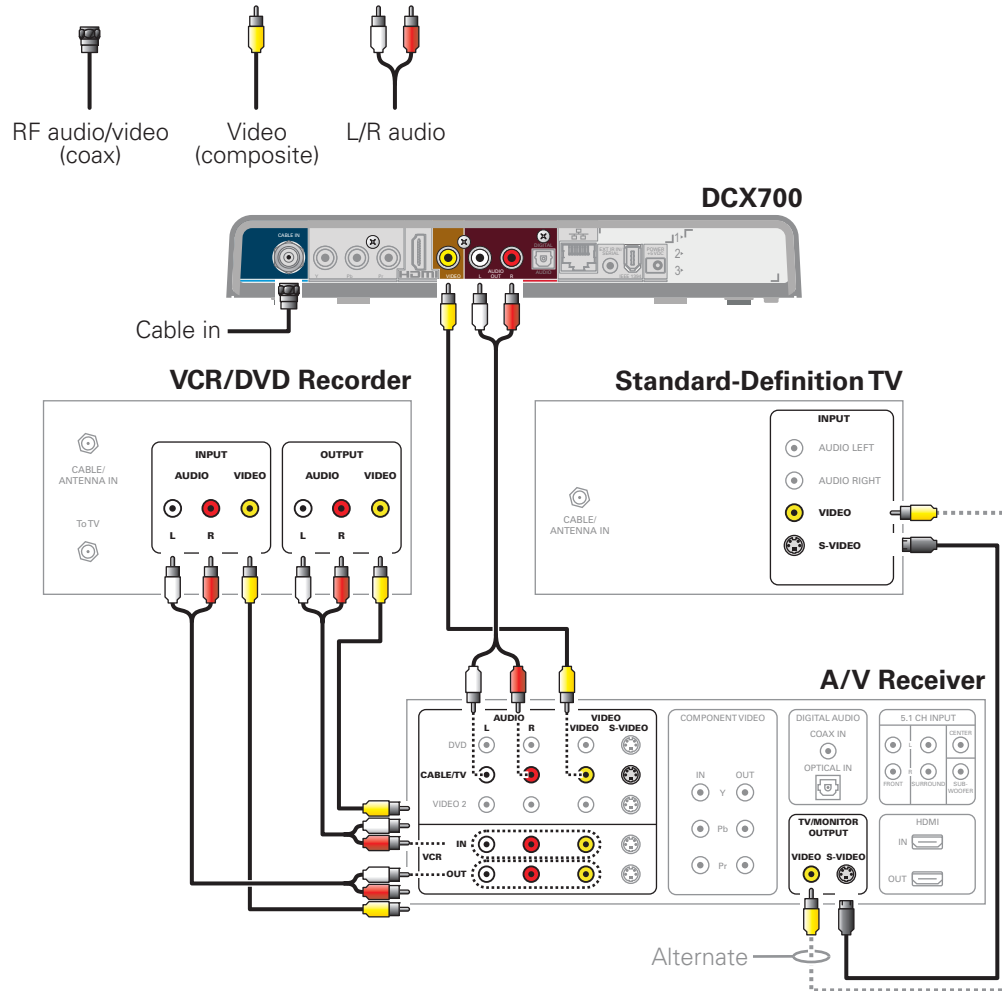

Note: Solid lines indicate optimum connections.

Note: Consult your A/V receiver manual for additional wiring options or constraints when including a VCR/DVD recorder in your configuration.



4

Recording Your Connections

Use this diagram to record connections between your home entertainment components. You can use this diagram to reconnect your system if you move the equipment or add new equipment.

Disconnect the power from the DCX set-top before connecting or changing cable connections. Do not place another component or object on top of the DCX set-top.

DCX700



VCR / DVD Recorder

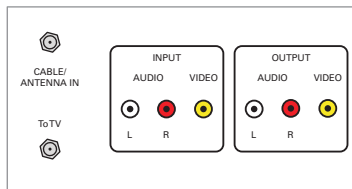

HDTV / Standard-Definition TV

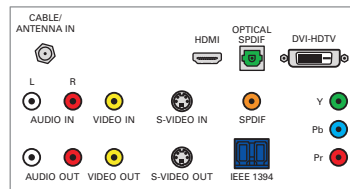

Audio receiver

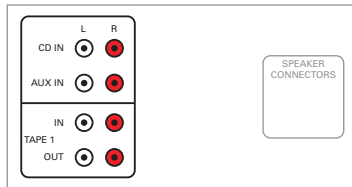

DVD player

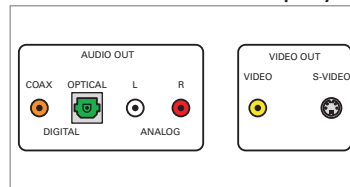

A/V receiver

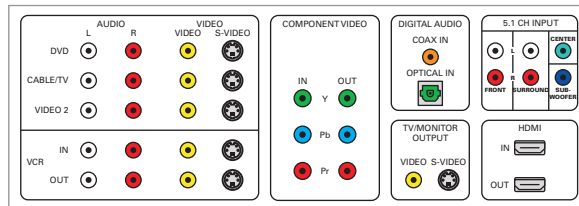



Data Devices

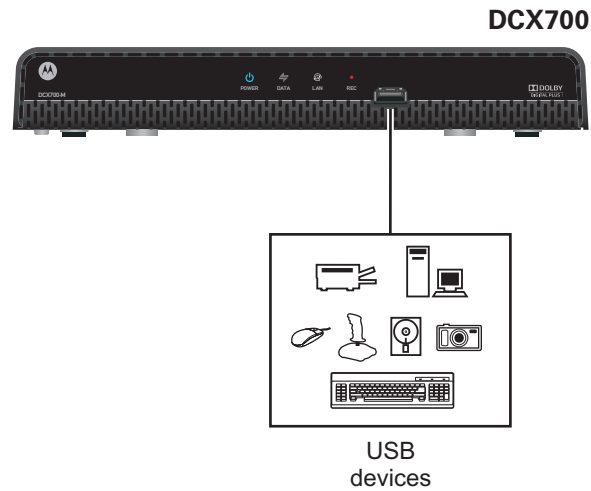

Note: Do not attempt to connect data devices without contacting your service provider. Advanced data features require the proper application and network infrastructure to operate.

Data Features

In addition to high-quality audio and video, the DCX set-top has the capability to deliver high-speed data services such as Internet access, e-mail, IP telephony, e-commerce, and home banking.

Note: Your DCX set-top may be equipped with the interface connections illustrated, but their functionality depends on the services offered by your service provider.



5

On-Screen Graphics

Your DCX set-top can generate graphics that overlay the video programming or fill the entire television screen. Common examples include on-screen menus (such as the User Setting menu), closed captions, and interactive program guides. The DCX set-top overlays these graphics whenever you open a menu, enable closed captions, or scroll through a program grid.

- On-screen graphics are not available on all video output combinations.
- On-screen graphics will not be displayed when you are using the IEEE-1394 connection on the rear panel of the DCX set-top.



6

Configuring A/V and Closed Caption Settings

The following describes how to configure the audio (for HDMI connections), SD and HD video settings, and closed caption settings for the DCX700.

Before you adjust the output settings:

- Connect the DCX700 to the TV and other home entertainment devices
- Plug the DCX700 into an AC power outlet
- Initialize the DCX700 and authorize it for services
- Turn the TV on

When using an HDMI connection between the DCX700 and the television, be sure to have the cable connected and the TV powered on before adjusting the video settings.

To configure the DCX700 settings on the main User Settings menu screen:

1. Ensure the DCX700 is installed properly and turned on.
2. Press POWER to put the set-top in stand-by mode. Within two (2) seconds press the MENU key on the remote control.
3. If the TV is on, the on-screen User Settings menu lists the DCX700 settings that can be adjusted:

Note: Depending on the Electronic Programming guide installed on the DCX700 by your service provider, you may need to press the MENU key twice to access the User Settings menu.



```

1          User Settings Menu
2
3 TV Type          16:9 (4:3 Letterbox, 4:3 Pan Scan)
4 YPbPr Output    1080i (720p, 480p, 480i, Native)
5   4:3 Override   480i (480p, Off, Stretch)
6
7 Native Mode Settings >>>
8 Additional HDMI Settings >>>
9
10 Closed Captions Disabled (Enabled)
11   Additional Closed Caption Settings >>>
12
13 Subtitle and DVS Settings >>>
14 Advanced Audio/Video Settings >>>
15
16
17 Auto Power Down 4 Hours (Disabled)
18
19
20 Restore All Defaults Menu Version 3.2

```

An example of the User Settings menu when the HDMI output is connected.

Note: The User Settings Menu indicates whenever an HDMI connection is in place between the DCX700 and another device.

When the HDMI connection is not being used the User Settings Menu will update to reflect the following:

```

1          User Settings Menu
2
3 TV Type          16:9 (4:3 Letterbox, 4:3 Pan Scan)
4 YPbPr Output    1080i (720p, 480p, 480i, Native)
5   4:3 Override   480i (480p, Off, Stretch)
6
7 Native Mode Settings >>>
8 Additional HDMI Settings >>>
9
10 Closed Captions Disabled (Enabled)
11   Additional Closed Caption Settings >>>
12
13 Subtitle and DVS Settings >>>
14 Advanced Audio/Video Settings >>>
15
16
17 Auto Power Down 4 Hours (Disabled)
18
19
20 Restore All Defaults Menu Version 3.2

```

An example of the User Settings menu when the HDMI output is not connected.

Use the remote control to navigate the on-screen menus:

Press the ▲ and ▼ keys to highlight the setting you wish to change.

Press the ► key to select an option.

To exit the setting and move to another setting, press the ▲ or ▼ key.

To exit the menu and save your settings, press the POWER or MENU key.



If the User Settings menu does not display on the HDTV screen, the TV may not support the default video output setting. Refer to “There is no video on the TV screen” in the *Troubleshooting* section.

The User Settings options:

| Setting | Description |
|--------------------------|---|
| TV Type | <p>The TV Type allows you to specify the style of television connected to the DCX700. Options include 16:9, 4:3 LETTERBOX, and 4:3 PAN SCAN. By default, the 16:9 option is selected. The options are used as follows:</p> <ul style="list-style-type: none"> • 16:9 designates that a widescreen television is connected to the DCX700. • 4:3 LETTERBOX designates that a standard-screen television is connected to the DCX700 and that widescreen programs should be scaled to fit the screen with black bars above and below the picture. • 4:3 PAN SCAN designates that a standard screen television is connected to the DCX700 and that widescreen programs should be cropped so that the picture fills the entire screen. |
| HDMI/YPbPr Output | <p>The HDMI/YPbPr Output setting allows you to specify the video output format of the DCX700 for all programs (when the 4:3 Override setting is set Off or Stretch) or for all widescreen programs (when the 4:3 Override is set to 480i or 480p). Options include 1080i, 720p, 480p, 480i, and Native. By default, the 1080i option is selected.</p> <p>The options are used as follows:</p> <ul style="list-style-type: none"> • 1080i — The DCX700 will present programs in the High-Definition 1080i format (1920 x 1080 pixels with interlaced scanning at 30 frames per second). • 720p — The DCX700 will present programs in the High-Definition 720p format (1280 x 720 pixels with progressive scanning at 60 frames per second). • 480p — The DCX700 will present programs in the Enhanced-Definition 480p format (720 x 480 pixels with progressive scanning at 60 frames per second). • 480i — The DCX700 will present programs in the Standard-Definition 480i format (720 x 480 pixels with interlaced scanning at 30 frames per second). • Native — The DCX700 will present programs in the format that most closely matches their native format according to the compatible formats selected from the “My TV Supports The Following Formats” list (see below). 1080p 24/30 will be presented natively. <p><i>Notes:</i></p> <ul style="list-style-type: none"> • <i>Some televisions may only support certain video formats. Please consult the television’s user manual for more information on video format compatibility.</i> • <i>The DCX700 can detect when the HDMI connection is in use. If you are not using the HDMI connection on the DCX700, the “HDMI/YPbPr Output” setting will display as “YPbPr Output” in the User Settings Menu.</i> |
| 4:3 Override | <p>The 4:3 Override setting allows you to specify the video output format of the DCX700 when it is tuned to a Standard-Definition program or playing back a Standard-Definition program from the DVR. Options include 480i, 480p, Stretch, and Off. By default, the 480i option is selected.</p> <p>The options are used as follows:</p> <ul style="list-style-type: none"> • 480i — The DCX700 will present Standard-Definition programs in the Standard-Definition 480i format (720 x 480 pixels). • 480p — The DCX700 will present Standard-Definition programs in the Enhanced-Definition 480p format (720 x 480 pixels). |



| Setting | Description |
|---|--|
| | <ul style="list-style-type: none"> • Stretch — The DCX700 will automatically stretch all Standard-Definition programs to a widescreen aspect ratio and present the video in the format designated by the HDMI/YPbPr Output setting. Note that the Stretch option is only available when the TV Type setting is 16:9. • Off — The DCX700 will create a widescreen version of a Standard-Definition program by adding black bars to the left and the right of the picture and present the video in the format designated by the HDMI/YPbPr Output setting. |
| | <p><i>Notes:</i></p> |
| | <ul style="list-style-type: none"> • <i>Some televisions may only support certain video formats. Please consult your television's user manual for more information on format compatibility.</i> |
| | <p><i>If the HDMI/YPbPr Output setting is set to either 480i or Native, the 4:3 Override feature is disabled and is no longer selectable in the menu. The 4:3 Override feature is available when the HDMI/YPbPr Output setting is 1080i, 720p, or 480p.</i></p> |
| Native Mode Settings | <p>The Native Mode Settings option allows you to customize the Native Mode feature of the DCX700 by selecting the video formats supported by your television. Selecting the Native Mode Settings option will present a new menu screen with settings specific to Native Mode operation. These settings are discussed in more detail below.</p> |
| | <p>The Native Mode Settings option is only available when the HDMI/YPbPr Output setting is set to Native. Otherwise, the Native Mode Settings option is disabled and no longer selectable in the menu.</p> |
| Additional HDMI Settings | <p>The Additional HDMI Settings option is available whenever an HDMI device is connected to the DCX700. Selecting the Additional HDMI Settings option will present a new menu screen with settings specific to the HDMI connection. These settings are discussed in more detail below.</p> |
| | <p>If no HDMI device is connected to the DCX700, the Additional HDMI Settings option is disabled and no longer selectable in the menu.</p> |
| Closed Captions | <p>The Closed Captions setting turns closed captions off or on.</p> |
| | <p>When this option is set to Disabled, the DCX700 does not render (draw) closed captions on any video output. When this option is set to Enabled, the DCX700 will render (draw) closed captions on all video outputs if closed captions are included within the program.</p> |
| | <p>By default, the Disabled option is selected.</p> |
| Additional Closed Caption Settings | <p>The Additional Closed Caption Settings option allows you to customize the style and appearance of closed captions.</p> |
| | <p>Selecting this option will present a new menu screen with settings specific to closed captions, including font style, color, and size. These settings are discussed in more detail below.</p> |
| | <p>The Additional Closed Caption Settings option is only available when the Closed Captions setting is set to Enabled. Otherwise, the Additional Closed Caption Settings option is disabled and no longer selectable in the menu.</p> |
| Subtitle and DVS Settings | <p>The Subtitle and DVS Settings option allows you to customize the operation of the subtitle and descriptive video service features.</p> |
| | <p>Selecting the Subtitle and DVS Settings option will present a new menu screen with settings specific to subtitle and descriptive video service operation. These settings are discussed in more detail below.</p> |



| Setting | Description |
|--------------------------------------|--|
| Advanced Audio/Video Settings | <p>The Advanced Audio/Video Settings option allows you to customize several advanced audio and video features of the DCX700.</p> <p>Selecting this option will present a new menu screen with settings specific to closed captions, including font style, color, and size. These settings are discussed in more detail below</p> |
| Auto Power Down | <p>The Auto Power Down setting allows you to configure the DCX700 to power off automatically after a period of inactivity. The options are used as follows:</p> <ul style="list-style-type: none"> • 4 Hours – The DCX700 will automatically power itself off after 4 continuous hours of inactivity. An alert screen will be displayed on your television indicating that the DCX700 is about to power itself down. You may press any key on the remote control, or the Power button on the front panel, while the alert screen is being displayed to prevent the DCX700 from powering itself down. • Disabled – The DCX700 will not automatically power itself off regardless of how long the period of inactivity. You must power off the DCX700 manually using either the remote control or the Power button on the front panel. <p><i>Note: Inactivity occurs when the DCX700 is powered on and tuned to a channel but has received no user input, either via the front panel or the remote control, for an extended period of time. Whenever the DCX700 receives input from the user, either through the use of the front panel or the remote control, the inactivity timer is reset.</i></p> |
| Restore All Defaults | <p>To reset all User Settings to their default values, move the cursor to this option and press the ► key.</p> |



Native Mode Settings Screen

The Native Mode Settings menu is used to configure the operation of the native mode feature on the DCX700. The DCX700 is capable of receiving and decoding a number of different digital video formats. When operating in native mode, the DCX700 will generate a video output format that most closely matches the broadcast video format.

For example, if the DCX700 is configured to operate in native mode, a channel broadcast in the 720p format will be output to the television in the 720p format, while a channel broadcast in the 1080i format will be output to the television in the 1080i format.

When using the native mode feature of the DCX700, please exercise caution when selecting the formats from the checklist. If a format is selected that is not compatible with the television, there may be a loss of video whenever the DCX700 is tuned to a channel which is broadcast in that format.

If the television is connected to the DCX700 using an HDMI cable, the DCX700 will automatically customize the checklist of supported formats as reported to it by the television. If the television is connected to the DCX700 using Component Video (YPbPr) cables, the checklist will need to be customized manually.

Note that at least one of the 1080i, 720p, 480p, or 480i formats must be selected from the checklist for the DCX700 to operate properly in native mode.

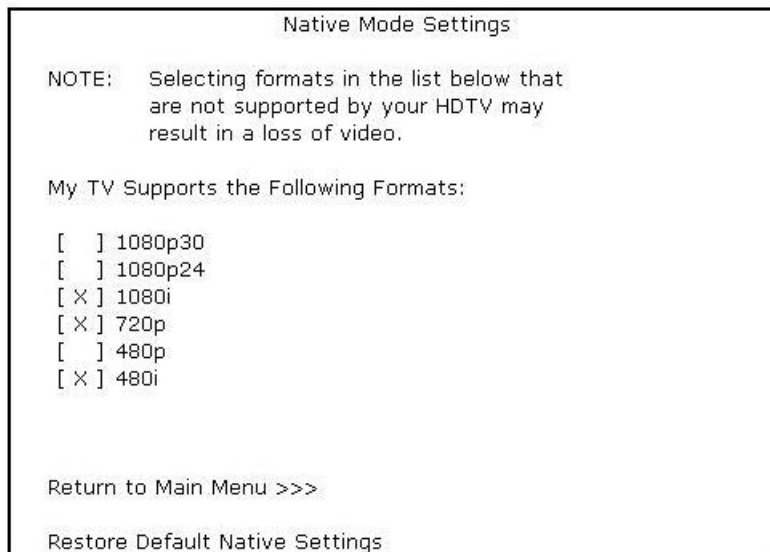

An example of the User Settings menu when configured for Native mode operation.

Note: Native mode operation only applies to the HDMI and Component Video (YPbPr) outputs.



| Setting | Description |
|--|--|
| 1080p30 (High Definition) | <p>When selected, the DCX700 will generate 1080p30 video on the HDMI output if the program is broadcast in 1080p30 format. The DCX700 cannot convert any other broadcast format to the 1080p30 video format. 1080p30 is a high-definition video image with 1920 x 1080 pixels, progressive scanning, and a frame rate of 30 frames per second. This option is only available if the DCX700 is connected to an HDMI display device. If no HDMI connection is detected, this option is disabled and no longer selectable in the menu.</p> <p><i>Note: The Component Video (YPbPr) output delivers 480i video whenever the HDMI output is delivering 1080p30 video.</i></p> |
| 1080p24 (High Definition) | <p>When selected, the DCX700 will generate 1080p24 video on the HDMI output if the program is broadcast in 1080p24 format. The DCX700 cannot convert any other broadcast format to the 1080p24 video format. 1080p24 is a high-definition video image with 1920 x 1080 pixels, progressive scanning, and a frame rate of 24 frames per second. This option is only available if the DCX700 is connected to an HDMI display device. If no HDMI connection is detected, this option is disabled and no longer selectable in the menu.</p> <p><i>Note: The Component Video (YPbPr) output delivers 480i video whenever the HDMI output is delivering 1080p24 video.</i></p> |
| 1080i (High Definition) | <p>When selected, the DCX700 will generate 1080i video on both the HDMI and Component Video (YPbPr) outputs if the program is broadcast in 1080i format. The DCX700 can also convert any other broadcast format to the 1080i video format. 1080i is a high-definition video image with 1920 x 1080 pixels, interlaced scanning, and a frame rate of 30 frames per second.</p> |
| 720p (High Definition) | <p>When selected, the DCX700 will generate 720p video on both the HDMI and Component Video (YPbPr) outputs if the program is broadcast in 720p format. The DCX700 can also convert any other broadcast format to the 720p video format. 720p is a high-definition video image with 1280 x 720 pixels, progressive scanning, and a frame rate of 60 frames per second.</p> |
| 480p (Enhanced Definition) | <p>When selected, the DCX700 will generate 480p video on both the HDMI and Component Video (YPbPr) outputs if the program is broadcast in 480p format. The DCX700 can also convert any other broadcast format to the 480p video format. 480p is an enhanced-definition video image with 720 x 480 pixels, progressive scanning, and a frame rate of 60 frames per second.</p> |
| 480i (Standard Definition) | <p>When selected, the DCX700 will generate 480i video on both the HDMI and Component Video (YPbPr) outputs if the program is broadcast in 480i format. The DCX700 can also convert any other broadcast format to the 480i video format. 480i is a standard-definition video image with 720 x 480 pixels, interlaced scanning, and a frame rate of 30 frames per second.</p> |
| Restore Default Native Settings | <p>Selecting this option will restore the checklist of video formats to its default configuration. Use this option if audio and/or video has been lost after adjusting these settings from their default values.</p> <p>If you are using the HDMI connection to your television, the checklist will be automatically customized according to the supported formats reported by the television.</p> <p>If you are using the Component Video (YPbPr) connection to your television, the checklist will have only the 1080i and 480i formats selected.</p> |



| Setting | Description |
|----------------------------|--|
| Return to Main Menu | Selecting this option will return you to the User Settings Menu main screen. |



Additional HDMI Settings Screen

To configure the DCX700 settings on the Additional HDMI Settings menu screen:

1. With an HDMI connection in place, power off the DCX700 and then immediately press the **MENU** key on the remote control.
2. This will display the main User Settings menu.
3. Move the cursor next to the “Additional HDMI Settings” option and press the ► key.

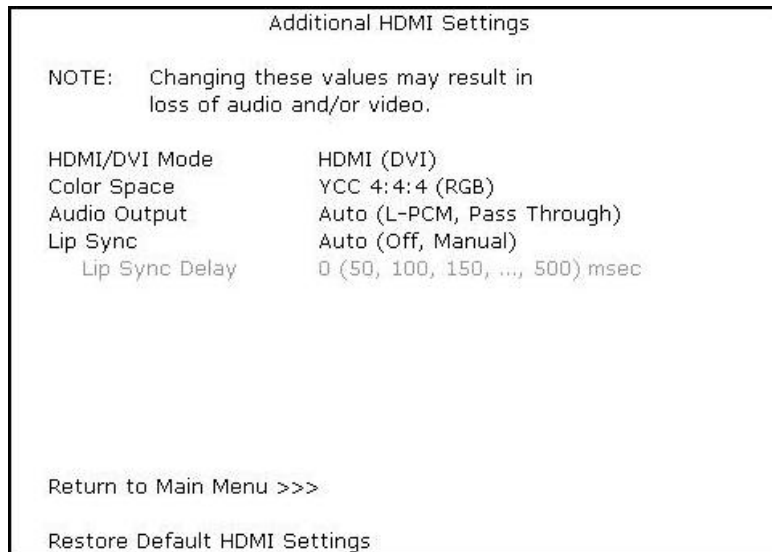

An example of the Additional HDMI Settings menu.

The Additional HDMI Settings menu options are:

| Setting | Description |
|----------------------|--|
| HDMI/DVI Mode | <p>The HDMI/DVI Mode setting allows you to optimize the HDMI output to work with both DVI-equipped televisions and HDMI equipped televisions. By default, this option is set to HDMI. The options are used as follows:</p> <ul style="list-style-type: none"> • HDMI – The DCX700 is optimized to work with an HDMI television or home theater receiver. • DVI – The DCX700 is optimized to work with a DVI television or display device (connected via an HDMI-to-DVI adapter). |
| Color Space | <p>The Color Space setting allows you to adjust the color space used by the DCX700 to generate the video signals on the HDMI output. By default, this option is set to YCC 4:4:4. The options are used as follows:</p> <ul style="list-style-type: none"> • YCC 4:4:4 – The DCX700 will generate video signals within the YCC color space. • RGB – The DCX700 will generate video signals within the RGB color space. <p><i>Note: Adjusting these settings could result in a loss of video. Only a professional installer or someone with a good working knowledge of the color spaces supported by the TV should change this setting.</i></p> |



| Setting | Description |
|--------------------------------------|---|
| Audio Output | <p>The Audio Output setting allows you to specify the digital audio format delivered over the HDMI output by the DCX700. Options include Auto, L-PCM, and Pass Through. By default, the Auto option is selected. The options are used as follows:</p> <ul style="list-style-type: none"> • Auto – The DCX700 will provide the digital audio format specified by the connected device (TV or home theater receiver) when that device was first connected to the DCX700. • L-PCM – The DCX700 will provide all audio in the Linear Pulse Code Modulation digital audio format. The L-PCM format is widely supported by most HDMI televisions and home theater receivers. • Pass Through – The DCX700 will provide the same digital audio format on the HDMI output as is provided with the program being viewed at that time. For example, if the program has a Dolby Digital soundtrack, the DCX700 will pass the Dolby Digital audio to the HDMI output. This option is most useful when connecting the DCX700 to a home theater receiver that has HDMI switching capability. <p><i>Note: Adjusting these settings could result in a loss of audio. Only a professional installer or someone with a good working knowledge of the digital audio formats supported by the TV and/or home theater receiver should change this setting</i></p> |
| Lip Sync | <p>The Lip Sync setting allows you to adjust the amount of time the audio signal is delayed with respect to the video signal on the HDMI output. Some HDMI televisions and home theater receivers add an extra delay to the video signal during processing which can produce an effect where the audio noticeably “leads” the video.</p> <p>By default, this option is set to Auto. The options are used as follows:</p> <ul style="list-style-type: none"> • Auto – The DCX700 will automatically delay the audio signal on the HDMI output by the amount of time requested by the connected HDMI device. • Manual – The DCX700 will delay the audio signal on the HDMI output by the amount of time selected for the Lip Sync Delay setting. • Off – The DCX700 will not delay the audio signal on the HDMI output. |
| Lip Sync Delay | <p>The Lip Sync Delay setting is only available when the Lip Sync option has been set to Manual. The Lip Sync Delay setting can be adjusted between 0 milliseconds (msec) and 500 milliseconds in 50 millisecond increments. If the Lip Sync option has been set to either Auto or Off, this option is disabled and no longer selectable in the menu.</p> <p>Use this option to adjust the HDMI audio delay if you notice that the video image routinely seems to be “behind” the audio soundtrack when using your HDMI device.</p> |
| Return To Main Menu | <p>Selecting this option will return you to the User Settings Menu main screen.</p> |
| Restore Default HDMI Settings | <p>Selecting this option will restore all of the settings on this screen (HDMI/DVI Mode, Color Space, Audio Output, and Lip Sync) to their default value. Use this option if audio and/or video has been lost after adjusting these settings from their default values.</p> |



Additional Closed Caption Settings Screen

To configure the DCX700 settings on the Additional Closed Caption Settings menu screen:

1. Power off the DCX700 and then immediately press the menu key on the front panel. This will display the main User Settings menu.
2. Move the cursor next to the "Closed Caption" option and adjust this setting to "Enabled."
3. The option to enter the Additional Closed Caption Settings menu is now available.

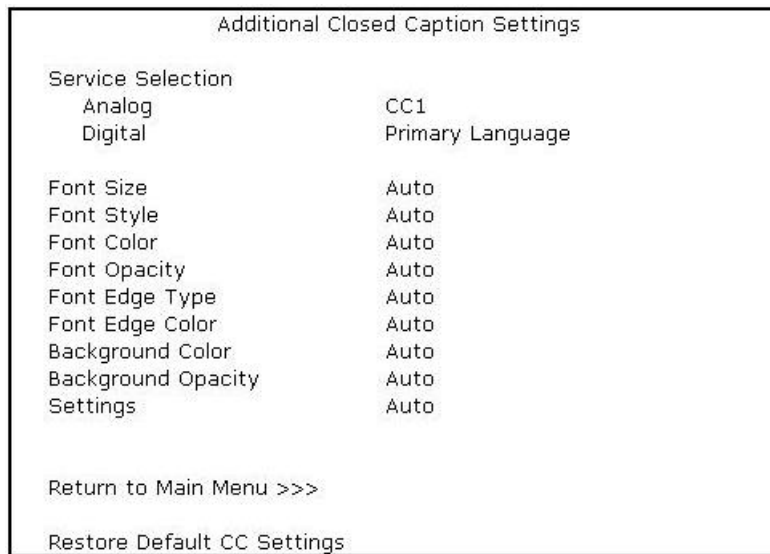

An example of the Additional Closed Caption Settings menu.



The Additional Closed Caption Settings menu options are:

| Setting | Description |
|------------------------------------|--|
| Service Selection | <p>Sets the service used by the DCX700 to render (draw) the closed captions:</p> <ul style="list-style-type: none"> • Analog – This setting affects closed captions for analog and digital standard definition services. Available options are: CC1, CC2, CC3, CC4, T1, T2, T3, or T4. The default setting is CC1. • Digital – This setting affects closed captions for digital enhanced definition and high definition services. Available options are: Primary Language, Secondary Language, 3, 4, 5, or 6. The default setting is Primary Language. |
| Font Size | Sets the font size used for rendering (drawing) closed captions. The default setting is Auto . Available options include: Auto, Standard, Large, or Small . |
| Font Style | Sets the font style used for rendering (drawing) closed captions. The default setting is Auto . Available options include: Auto, Mono Serif, Proportion Serif, Mono No Serif, Proportion No Serif, Casual, Cursive, or Small Capitals . |
| Font Color | Sets the font color used for rendering (drawing) closed captions. The default setting is Auto . Available options include: Auto, White, Black, Red, Green, Blue, Yellow, Magenta, or Cyan . |
| Font Opacity | Sets the opacity used for rendering (drawing) closed captions. The default setting is Auto . Available options include: Auto, Transparent, Translucent, Solid, or Flashing . |
| Font Edge Type | Sets the edge appearance used for rendering (drawing) closed captions. Available options include: Auto, None, Raised, Depressed, Uniform, Left Shadowed, or Right Shadowed . The default setting is Auto . |
| Font Edge Color | Sets the edge color used for rendering (drawing) closed captions. Available options include: Auto, White, Black, Red, Green, Blue, Yellow, Magenta, or Cyan . The default setting is Auto . |
| Background Color | Sets the background color used for rendering (drawing) closed captions. The default setting is Auto . Available options include: Auto, White, Black, Red, Green, Blue, Yellow, Magenta, or Cyan . |
| Background Opacity | Sets the background opacity used for rendering (drawing) closed captions. The default setting is Auto . Available options include: Auto, Transparent, Translucent, Solid, or Flashing . |
| Settings | Sets the default settings for closed captions (Auto) or restores the settings you had previously configured (User) allowing you to easily change the closed caption settings between their default settings and your customized settings. The default setting is Auto . Available options include: Auto or User . |
| Return To Main Menu | Selecting this option will return you to the User Settings Menu main screen. |
| Restore Default CC Settings | To reset all of the Additional Closed Caption settings to their default values, navigate to this option and press the ► key. |



Subtitle and DVS Settings Screen

The Subtitle and DVS Settings menu is used to customize the language and appearance of subtitles and to turn the descriptive video service feature on and off on the DCX700. Subtitles allow a viewer to watch television programs and movies which contain dialogue that is not in the viewer's native language. Subtitles are not included within many television programs (unlike closed captions).

A descriptive video service (DVS) is a special secondary audio track which is included within many television programs and is intended to assist the visually impaired. The DVS audio track provides a verbal description of each scene along with the program's normal dialogue.

The Subtitle and DVS Settings menu screen is shown in the following image and discussed in the following table.

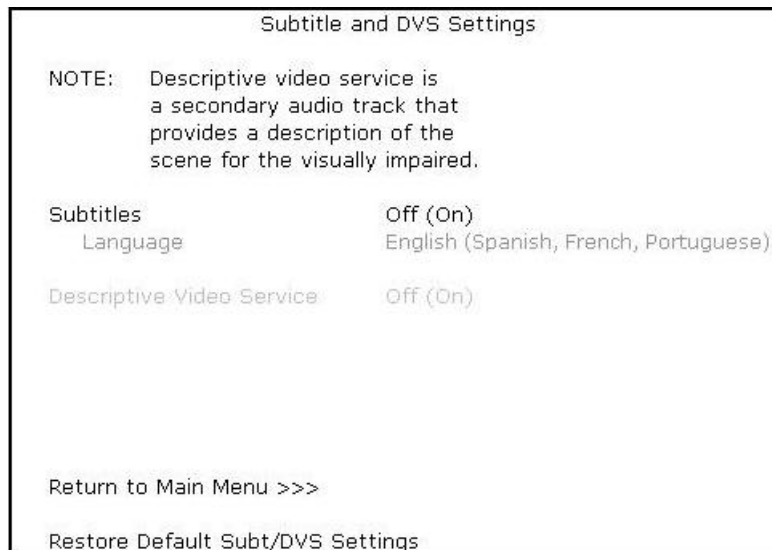

An example of the Subtitle and DVS Settings menu.



| Setting | Description |
|--|--|
| Subtitles | <p>The Subtitles setting is used to control the display of subtitles. The default setting is Off. The options are used as follows:</p> <ul style="list-style-type: none"> • Off – Subtitles are not rendered (drawn) by the DCX700. • On – Subtitles are rendered (drawn) by the DCX700 if they are included within the program and in the language specified by the Language setting. <p>When the Subtitles option is set to On, the Language selection option becomes selectable from the menu.</p> |
| Language | <p>The Language setting is only available when the Subtitles option is set to On. Otherwise, this setting is disabled and no longer selectable in the menu. The default language selection is English. The options are used as follows:</p> <ul style="list-style-type: none"> • English – The DCX700 will render (draw) subtitles in the English language if they are included within the program. • Spanish – The DCX700 will render (draw) subtitles in the Spanish language if they are included within the program. • French – The DCX700 will render (draw) subtitles in the French language if they are included within the program. • Portuguese – The DCX700 will render (draw) subtitles in the Portuguese language if they are included within the program. <p><i>Note: The DCX700 is not capable of translating subtitles from one language into another language. For example, if French subtitles are included with the program, the DCX700 cannot translate them to into Portuguese if the Language option has been set to Portuguese. The DCX700 can only display subtitles in the language(s) that have been included within the program.</i></p> |
| Descriptive Video Service | <p>The Descriptive Video Service setting is used to control the DVS feature of the DCX700. The default setting is Off. The options are used as follows:</p> <ul style="list-style-type: none"> • Off – The DVS audio track is not played by the DCX700. • On – The DVS audio track is player by the DCX700 if it is included within the program. <p><i>Note: If the DVS setting is disabled and not selectable from the menu, the software installed on the DCX700 is not yet capable of supporting the DVS feature. The DVS feature will become enabled with a future software upgrade.</i></p> |
| Return To Main Menu | <p>Selecting this option will return you to the User Settings Menu main screen.</p> |
| Restore Default Subt/DVS Settings | <p>To reset all of the Subtitle and DVS settings to their default values, navigate to this option and press the ► key.</p> |



Advanced Audio/Video Settings Screen

The Advanced Audio/Video Settings menu is used to customize several advanced audio and video features of the DCX700, most notably the Dolby Volume feature and the Video Sharpness feature.

The Dolby Volume feature provides volume normalization across channels, programs, and commercials. Normalization is a process where the different volume levels across channels, programs, and commercials are adjusted to the same approximate output volume. As a result, sudden volume changes are reduced and the overall volume output of the DCX700 is more consistent.

The Video Sharpness feature is used to soften or sharpen Standard Definition (SD) programs when viewed on either the HDMI or Component Video (YPbPr) outputs. When SD programs are viewed on a large screen television, picture quality can suffer because noise and other imperfections in the picture can be magnified on the large display. The Video Sharpness feature can be used to soften the picture and reduce the appearance of these imperfections.

The Advanced Audio/Video Settings menu screen is shown in the following image and discussed in the following table.

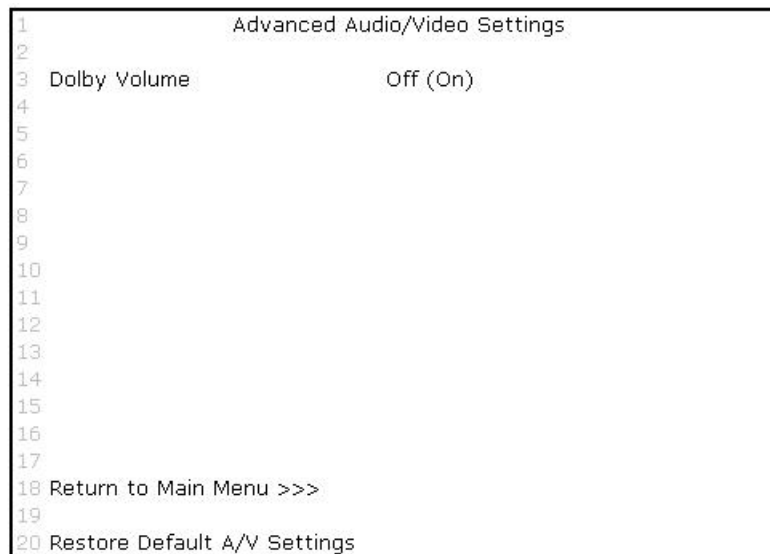

An example of the Advanced Audio/Video Settings menu.



| Setting | Description |
|-------------------------------------|---|
| Dolby Volume | <p>The Dolby Volume setting is used to control the Dolby Volume feature of the DCX700. The default setting is Off. The options are used as follows:</p> <ul style="list-style-type: none">• Off – The Dolby Volume feature is turned off and the output volume may fluctuate during commercials or when changing channels.• On – The Dolby Volume feature is turned on and the DCX700 will maintain a more consistent output volume regardless of the channel or program being viewed. |
| Return To Main Menu | Selecting this option will return you to the User Settings Menu main screen. |
| Restore Default A/V Settings | To reset all of the Advanced Audio/Video settings to their default values, navigate to this option and press the ► key. |



7

Troubleshooting

Before calling your service provider, review this troubleshooting guide. This information is to help you quickly solve a problem. If your problem still exists, contact your service provider.

| Problem | Possible Solution |
|---|---|
| The DCX set-top will not power on | <p>The DCX set-top may have received a software update and may not power on while the new software is being installed. Try again in a few minutes.</p> <ul style="list-style-type: none"> • Verify that the AC power cord of the external power supply is connected to the DCX set-top and an AC outlet. Unplug the DCX set-top from the AC outlet, plug it back in, and then press the POWER button on the remote control. • If the DCX set-top is connected to a switched outlet on another unit, verify that that unit is powered on. Unplug the power cord from the DCX set-top's AC outlet, plug it back in, and then press the POWER button on the remote control. Use an unswitched outlet, if possible. • The batteries in the remote control may be depleted. |
| The remote control does not work | <p>Verify that the remote control is in "Cable" mode. Verify that there are no obstructions between the remote control and the DCX set-top. Aim the remote control directly at the DCX set-top front panel, not the TV or VCR. The angle between the remote control and the DCX set-top may be too large. Stand in front of the DCX set-top and not too far to either side.</p> <ul style="list-style-type: none"> • Press and release operation keys one at a time, firmly and deliberately. • Check the batteries in the remote control. And replace if needed. |
| There is no audio when viewing cable channels | <p>Verify that the mute button on the remote control has not been pressed. Press mute on the remote control to restore sound.</p> <ul style="list-style-type: none"> • If the DCX set-top audio output is connected to the TV, verify that the mute button on the TV has not been pressed. • If the DCX set-top audio output is connected to a home theater receiver, verify that the receiver is set to the appropriate input source and the mute button on the receiver has not been pressed. • Verify that you have the correct cables for the audio connections. • Verify that the audio cables are firmly connected between the DCX set-top and the audio playback device (TV, receiver, DVD player, etc.). |



| Problem | Possible Solution |
|---|---|
| <p>There is no audio from the center and/or surround speakers of a home theater receiver connected to the DCX set-top</p> | <p>Not all programs feature full Dolby Digital [5.1] or Dolby Digital Plus [7.1] full surround sound. In some cases, the programs may only contain left and right stereo audio.</p> <ul style="list-style-type: none"> • Verify that the S/PDIF (coaxial or optical) audio cable is firmly connected to the DCX set-top and the home theater receiver. • Verify that the home theater receiver is set to a surround sound audio mode (Dolby Pro Logic®, Dolby Pro Logic II®, Dolby Pro Logic IIx®). • Verify that the receiver is properly configured to work with all connected speakers. |
| <p>There is no video on the TV screen</p> | <p>Verify that the TV is powered on and set to the appropriate input source for the DCX set-top.</p> <p>Verify that the DCX set-top is powered on and tuned to an authorized cable channel.</p> <p>Verify that all video cables between the DCX set-top and the TV are firmly connected.</p> <p>Verify that the coaxial cable feed is firmly connected to the DCX set-top and the wall jack.</p> <ul style="list-style-type: none"> • If the DCX set-top video output is connected to a home theater unit, verify that the home theater unit is powered on and set to the appropriate input source. • If the DCX set-top video output is connected to a TV through an HDMI connection, power off the TV and then power off the DCX set-top. Wait one second and then power on the devices. <p>Not all HDTVs can display every output format (1080p, 1080i, 720p, 480p, or 480i) available on the DCX set-top. To select a different format:</p> <ol style="list-style-type: none"> 1. Ensure that your DCX set-top is plugged into a power outlet and is turned off. 2. Connect the DCX set-top to your television using a Standard-Definition connector. 3. Turn on the DCX set-top with your remote control. 4. Press the Menu button on the remote control. 5. Press the ▲ and ▼ keys to display the HDMI/YPbPr OUTPUT setting. 6. Press the ► key to cycle through the available output formats until the HDTV connection you would like to use is selected.. |
| <p>No graphics or program guides appear on the TV screen</p> | <p>If you use the IEEE-1394 connection, on-screen graphics, including closed captions and program guides, are not displayed by the DCX set-top. On-screen graphics and captions may still be overlaid by your TV, if enabled. Alternatively, use HDMI or component video instead.</p> |
| <p>No closed captions display</p> | <p>Verify on the User Settings menu that closed captions are enabled on the DCX set-top.</p> <p>Verify that closed captions are enabled on the TV.</p> <p>Note: Closed captioning may not be available on the current program.</p> |



| Problem | Possible Solution |
|--|---|
| <p>There are black bars to the right and left of the picture</p> | <p>Wide screen TVs display 4:3 programs in this format unless set to Stretch. Turn on the 4:3 OVERRIDE feature in the User Settings menu. This enables most wide screen TVs to stretch the video to fill the screen (see your TV manual for information about stretching 4:3 video).</p> <ul style="list-style-type: none"> • If the DCX700 is connected to a wide screen TV, verify that the TV TYPE is set to 16:9 in the User Settings menu. Many HD programs are broadcast in pillar-box format with black bars to the left and right of the picture. These programs are broadcast in 16:9 HD formats even though the video is not 16:9. |
| <p>There are black bars above and below the picture</p> | <p>All 4:3 HDTVs display HD programs in letterbox format (black bars above and below the picture) because of the shape of the display screen.</p> <ul style="list-style-type: none"> • Turn on the 4:3 OVERRIDE feature in the User Settings menu. This enables most standard screen TVs to display a full screen picture when the DCX700 is tuned to a 4:3 program. • Set the TV TYPE to 4:3 Pan-Scan. This enables the DCX700 to remove the black bars above and below the picture when possible. <p>Some SD programs are broadcast in the letterbox format with black bars above and below the picture. Some widescreen TVs offer a zoom feature that may be able to remove the black bars (see your TV manual for information about zooming 4:3 video).</p> |
| <p>There are black bars on all four sides of the picture</p> | <p>This may occur on a 4:3 TV if the 4:3 OVERRIDE setting is OFF. To set 4:3 SD programming to fill the screen, depending on the capabilities of the TV, set 4:3 OVERRIDE to 480i or 480p.</p> <p>This may occur on a 16:9 TV if the active video for an SD broadcast is in letterbox format. To confirm, wait for a commercial or look for a graphic, such as a network logo. If the commercial fills the screen from top to bottom, or the graphic appears below the active video, the program is being letterboxed by the broadcaster. You can minimize this by activating the zoom feature on the TV.</p> <p>A broadcaster may include black bars on either side of a wide screen broadcast. This is called a "hybrid" aspect ratio and results in a black border surrounding the video on a 4:3 TV. Because this is part of the broadcast, the DCX700 cannot correct the video. You may be able to minimize the border using the zoom feature on the TV.</p> |
| <p>Colors do not appear correctly</p> | <p>Be sure to match up each signal to the same YPbPr connection on the TV, otherwise the colors will not appear correctly on your TV.</p> |



Appendix A

Wall Mounting Your DCX700

If you mount your DCX700 on the wall, you must:

- Locate the unit as specified by the local or national codes governing residential or business cable TV and communications services.
- Follow all local standards for installing a network interface unit/network interface device (NIU/NID).

If possible, mount the unit to concrete, masonry, a wooden stud, or some other very solid wall material. Use anchors if necessary (for example, if you must mount the unit on drywall).

Note: Motorola recommends the use of an External IR receiver Cord (part number 571984) if wall mounting the DCX700.

Caution!



Before drilling holes, check the structure for potential damage to water, gas, or electric lines.

If necessary, seat an anchor in each hole.

Make sure the AC power plug is disconnected from the wall outlet and all cables are removed from the back of the DCX700 before starting the installation.

Do the following to mount your DCX700 on the wall:

1. Use *Figure 1* to determine the space required between keyholes.
2. Use a center punch to mark the center of the holes.
3. On the wall, locate the marks for the mounting holes.

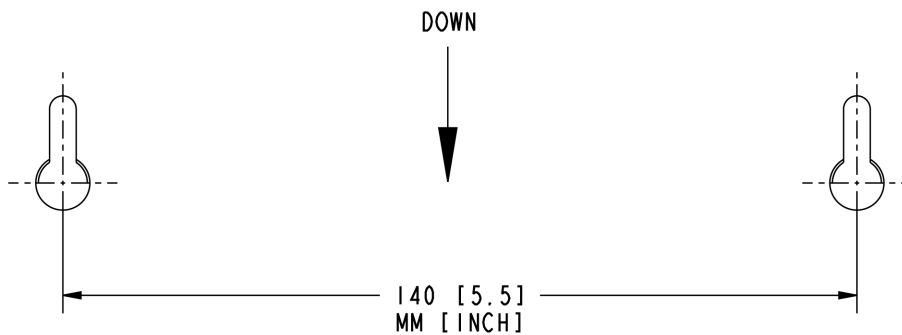
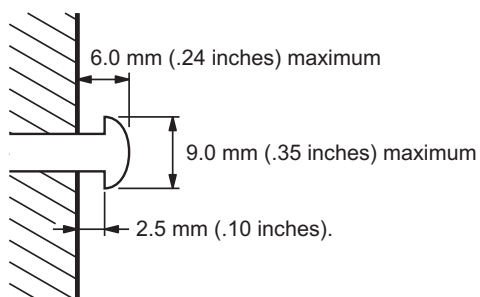

Figure 1 – DCX700 Wall Mounting Template

4. Drill the holes to a depth of at least 1 1/2 inches (3.8 cm). Use M3.5 x 38 mm (#6 x 11/2 inch) screws with a flat underside and maximum screw head diameter of 9.0 mm to mount the DCX700.
5. Using a screwdriver, turn each screw until part of it protrudes from the wall, as shown in the following illustration.



There must be 0.10 inches (2.5 mm) between the wall and the underside of the screw head.

6. Place the DCX700 so the keyholes on the back of the unit are aligned above the mounting screws.
 7. Slide the DCX700 down until it stops against the top of the keyhole opening.
- After mounting, reconnect all cables and plug the power cord into the +5VDC connector on the unit and the electrical outlet. Route the cables so that they are not a safety problem.



Motorola, Inc.
101 Tournament Drive
Horsham, PA 19044 U.S.A.

<http://www.motorola.com>

365-095-14284 x.1 04/2010